

D6F-W

MEMS Flow Rate Sensor

A Compact Sensor That Uses OMRON's Unique Flow Path Structure for High-performance Flow Rate Measurement.

- Anti-dust performance enhanced by OMRON's unique three-dimensional flow path structure.
- High accuracy of $\pm 5\%$ FS.



RoHS Compliant



Refer to the Safety Precautions on page 3.

Ordering Information

Model	Applicable fluid (See note 1.)	Flow rate range	Minimum order
D6F-W01A1	Air (See note 2.)	0 to 1 m/s	25
D6F-W04A1		0 to 4 m/s	25
D6F-W10A1		0 to 10 m/s	25
D6F-W CABLE (Optional)	-	-	25

Note: 1. The Sensor be calibrated for different gas types. Consult your Omron representative.
 Note: 2. Dry gas must not contain large particles, e.g., dust, oil, or mist.

Output Voltage Characteristics

D6F-W01A1

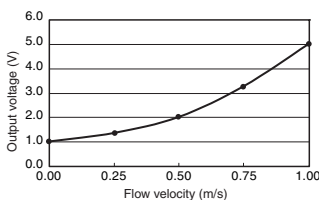

D6F-W04A1

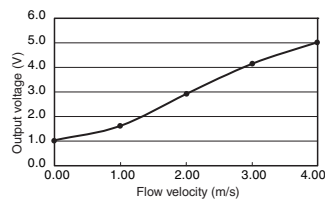

D6F-W10A1

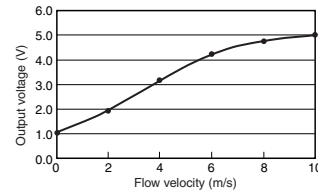

D6F-W01A1

Flow velocity m/s	0	0.25	0.50	0.75	1.00
Output voltage V	1.00 \pm 0.2	1.35 \pm 0.2	2.01 \pm 0.2	3.27 \pm 0.2	5.00 \pm 0.2

D6F-W04A1

Flow velocity m/s	0	1.0	2.0	3.0	4.0
Output voltage V	1.00 \pm 0.2	1.58 \pm 0.2	2.88 \pm 0.2	4.11 \pm 0.2	5.00 \pm 0.2

The flow velocity is the value calculated from the mass flow rate in OMRON's specified 48-mm-dia. wind tunnel. It does not indicate the flow velocity determined by the Measurement Law of Japan. The wind tunnel conditions are shown in Figure 1, below.

Figure 1: Wind Tunnel

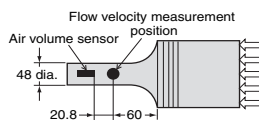

Measurement conditions: Power supply voltage of 12 VDC, ambient temperature of 25°C, and ambient humidity of 35% to 75%.

D6F-W10A1

Flow velocity m/s	0	2.0	4.0	6.0	8.0	10.0
Output voltage V	1.00 \pm 0.24	1.94 \pm 0.24	3.23 \pm 0.24	4.25 \pm 0.24	4.73 \pm 0.24	5.00 \pm 0.24

The flow velocity is the value calculated from the mass flow rate in OMRON's specified 155-mm-dia. wind tunnel. It does not indicate the flow velocity determined by the Measurement Law of Japan. The wind tunnel conditions are shown in Figure 2, below.

Figure 2: Wind Tunnel

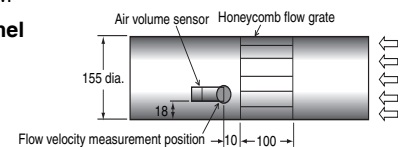

Measurement conditions: Power supply voltage of 12 VDC and ambient temperature of 25°C

Connections

D6F-W01A1
D6F-W04A1
D6F-W10A1

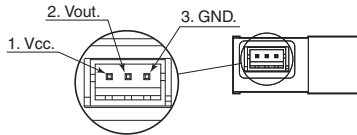

Enlarged View
Pin No. 1: Vcc
2: Vout
3: GND
Connector S3B-ZR-SM2-TF (made by J.S.T. Mfg. Co.)

Use the following connectors from J.S.T. Mfg. Co. Ltd. to connect the D6F:
Contacts and Wires

Contacts: SZH-002T-P0.5
Wires: AWG28 to AWG26
Or
Contacts: SZH-003T-P0.5
Wires: AWG32 to AWG28
Housing: ZHR-3

Characteristics/Performance

Model	D6F-W01A1	D6F-W04A1	D6F-W10A1
Flow Range (See note 1.)	0 to 1 m/s	0 to 4 m/s	0 to 10 m/s
Calibration Gas (See note 2.)	Air		
Electrical Connection	Three-pin connector		
Power Supply	10.8 to 26.4 VDC		
Current Consumption	15 mA max. with no load, with a Vcc of 12 to 24 VDC, and at 25°C		
Output Voltage	1 to 5 VDC (non-linear output, load resistance of 10 kΩ)		
Accuracy	±5% FS (25°C characteristic)		±6% FS (25°C characteristic)
Repeatability (See note 3.)	±0.4% FS		
Output Voltage (Max.)	5.7 VDC (Load resistance: 10 kΩ)		
Output Voltage (Min.)	0 VDC (Load resistance: 10 kΩ)		
Rated Power Supply Voltage	26.4 VDC		
Rated Output Voltage	6 VDC		
Case	PPS		
Degree of Protection	IEC IP40		
Operating Temperature	-10 to 60°C (with no condensation or icing)		
Operating Humidity	35% to 85% (with no condensation or icing)		
Storage Temperature	-40 to 80°C (with no condensation or icing)		
Storage Humidity	35% to 85% (with no condensation or icing)		
Temperature Characteristics	±5% FS for 25°C characteristic at an ambient temperature of -10 to 60°C		
Insulation Resistance	Between Sensor outer cover and lead terminals: 20 MΩ min. (at 500 VDC)		
Dielectric Strength	Between Sensor outer cover and lead terminals: 500 VAC, 50/60 Hz min. for 1 min (leakage current: 1 mA max.)		
Weight	6.3 g		

Note: 1. A 0 to 1 L/min. (normal) volumetric flow rate at 0°C, 101.3 kPa.
Note: 2. Dry gas. (must not contain large particles, e.g., dust, oil, or mist.)
Note: 3. Reference (typical)

Dimensions (Unit: mm)

D6F-W01A1
D6F-W04A1
D6F-W10A1

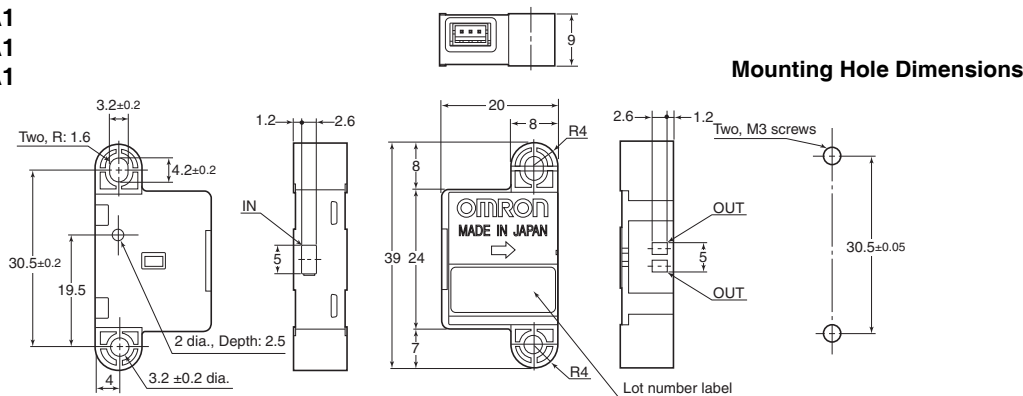

■ Cable (Optional)

D6F-W CABLE

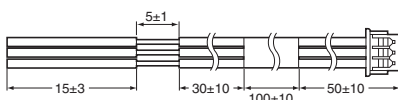

Safety Precautions

WARNING

The D6F is built for use with general-purpose devices. In cases such as those described below, where safety is required, implement measures to ensure the safety of the system and all devices, such as fail-safe designs, redundancy designs, and regular maintenance.

- Safety devices for ensuring safety for persons
- Transportation equipment control (such as applications to stop operation)
- Aviation and space equipment
- Nuclear power equipment

Do not use the D6F for applications in which D6F operation would directly affect human life.

Caution

Make sure that the power to all equipment is turned OFF before you install the Sensor. Installing the Sensor while the power supply is ON may result in electrical shock or abnormal operation.

Precautions for Correct Use

● Fluids, Tubes, and Sensor Installation

All Models

- (1) Use clean fluids. Dust and mist can affect the characteristics of the Sensor or damage the Sensor. Install a filter and mist separator on the upstream tube.
(Not required for the D6F-W□A1 or D6F-P.)
- (2) Do not use combustible gases (e.g., hydrogen), corrosive gases (e.g., chlorine, sulfur, acidic, or alkali gas), or other non-approved fluids. They may damage the Sensor.
- (3) The performance specifications that are given for the G6F do not apply if any fluids other than the specified applicable fluid are used.
- (4) Foreign matter in the tubes that are connected to the Sensor may damage the Sensor. Prevent any foreign matter from entering the tubes after the Sensor is removed from its packaging.
- (5) Attach the tubes so that fluid flows only in the direction designated by the arrows on the Sensor. Correct measurements cannot be obtained if the fluid flows in the wrong direction.
- (6) We recommend that you install the tubes horizontally. If the tubes are not installed horizontally, an error of $\pm 1\%$ FS or higher may result.
(This does not apply to the D6F-03A3.)
- (7) Install the Sensor on a flat surface. Incorrect installation may damage the Sensor and make it impossible to obtain correct measurements.
- (8) After the Sensor is installed, check to confirm that it operates correctly.
- (9) Do not drop the Sensor, remove the cover, or attempt to disassemble the Sensor in any way.

D6F-W01A1, D6F-W04A1, and D6F-W10A1

- (1) Depending on the ambient environment and installation location, dust, dirt, and other foreign matter may build up

inside the Sensor and block part or all of the flow path or accumulate on internal components. This may result in the Sensor not being able to perform to the specifications given above. Always perform a pre-evaluation on your actual equipment and be aware of the possible problems that may occur before you use the Sensor for the actual equipment.

- (2) Use M3 panhead screws to install the Sensor, and tighten them to a maximum torque of 0.59 N·m.

● Operating Environment

Do not use the Sensor in the following locations:

- Locations directly subject to heat radiated from heating equipment
- Locations subject to water or oil
- Locations subject to direct sunlight
- Locations subject to intense temperature changes
- Locations subject to icing or condensation
- Locations subject to excessive vibration or shock

● Countermeasures against Noise

Noise may make it impossible to obtain correct measurements. Consider the following countermeasures.

- Allow as much space as possible between the Sensor and devices that generate high frequencies (such as high-frequency welders and high-frequency sewing machines) or surges.
- Attach surge absorbers or noise filters to noise-generating devices that are near the Sensor (in particular, equipment with inductance, such as motors, transformers, solenoids, and magnetic coils). (It also helps to separate pipes and ducts, and to use shielded cables.)

● Power Supply

- Do not directly solder power supply leads to the connector terminals. Use only the appropriate connectors.
- Wire with the correct terminal names and polarities. Incorrect wiring will cause failure of internal components.
- When using a commercially available switching regulator, ground the FG (frame ground) and G (ground) terminals.

RoHS Directive

The RoHS mark is displayed on the packing of products for which the six substances banned by the RoHS Directive have been abolished (both in processing and in the electronic components mounted to the PCBs).

* RoHS marking may be terminated if it is later determined that parts that were previously treated as RoHS compliant are not compliant due to circumstances at the supplier of the parts.

● RoHS Compliance Criteria

The following standards are used to determine RoHS compliance for the six banned substances.

(Items to which the RoHS Directive is not applicable are not given.)

- Lead: 1,000 ppm max.
- Hexavalent chromium: 1,000 ppm max.
- Mercury: 1,000 ppm max.
- PBB: 1,000 ppm max.
- Cadmium: 100 ppm max.
- PBDE: 1,000 ppm max.

• Application examples provided in this document are for reference only. In actual applications, confirm equipment functions and safety before using the product.
• Consult your OMRON representative before using the product under conditions which are not described in the manual or applying the product to nuclear control systems, railroad systems, aviation systems, vehicles, combustion systems, medical equipment, amusement machines, safety equipment, and other systems or equipment that may have a serious influence on lives and property if used improperly. Make sure that the ratings and performance characteristics of the product provide a margin of safety for the system or equipment, and be sure to provide the system or equipment with double safety mechanisms.